

ROBAND® 

sycloid®
TOASTER

With bun
toasting
mode





sycloid® TOASTER

The Hottest Toaster that's "Cool-to-Touch"

FEATURES

Robust & durable stainless steel elements

Hinged top cover allowing easy access to clean inside

Will toast bread & buns up to 30 mm thickness

"Cool Touch" Safe external touch temperatures

Adjustable speed control to modify the toasting time with electronic setting lock feature

NEW

Modern brushed stainless steel exterior

Intelligent energy saving capability

NEW

Warm toast chute with cut-away sides allow diners to easily see when their toast is ready

Bun mode to toast cut side of bun up to 30 mm & warm crown

Slide-out crumb tray for every-day cleaning

LED lights illuminate toast holding bay

Produces a beautiful toasting result

Also available in these colours:



Red

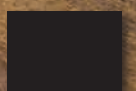

Black



The stylish and intelligent Sycloid® toaster







Elegantly designed and crafted, the revolutionary Sycloid® toaster sets a new standard for high speed toast production. The Sycloid's stylish exterior houses a cleverly engineered machine that provides truly functional energy efficient operation and an outstanding toasting result time after time.

Features

- Available in red, black or natural colours with the option of either 10 amps producing over 350 slices per hour, or 13 amps, producing over 500 slices per hour.
- All Sycloid toasters deliver excellent toasting results for bread up to 30 mm thickness. As most bread used in buffets is expected to be less than 20 mm thickness, the Sycloid is optimised to deliver its best result for bread of this thickness, but can accommodate slices up to 30 mm.
- The new bun toast feature allows for toasting bun halves up to 30 mm thick. The Sycloid balances heat to perfectly toast on the cut side - whilst warming the crown.
- Patron and staff safety is paramount and the Sycloid® toaster has been designed with "cool to touch" safe external touch temperatures and a lid locking latch.
- Intelligent energy efficient design – an automatic power-save mode conserves energy during quiet periods by scaling back energy consumption when in toast mode. The intelligent auto-sense feature detects when a new slice is placed in the machine and automatically prepares the machine to toast the bread. The heat setting in this mode is balanced and optimised to ensure quick recovery.
- A user-friendly and reliable speed controller allows adjustment of the toasting time to account for different types of bread or buns to be toasted. The knob setting lock feature allows staff to set the toasting speed, removing the risk of patrons altering the setting.
- Diners can easily see when their toast is ready from across the buffet with the stylishly sculpted toast return chute with LED lighting that provides easy and illuminated viewing of the toast holding bay. The wide opening of the bay allows easy access to toast, which the radiant heat from the elements helps to keep warm.
- Featuring robust stainless steel elements, the Sycloid® toaster also features a modern brushed stainless steel exterior, perfect for disguising finger prints on a machine expected to be heavily used. It also includes a slide-out crumb tray for every-day cleaning and a hinged top cover allowing easy access to clean the inside.
- The Sycloid® toaster produces a beautiful toasting result throughout the entire slice of bread.

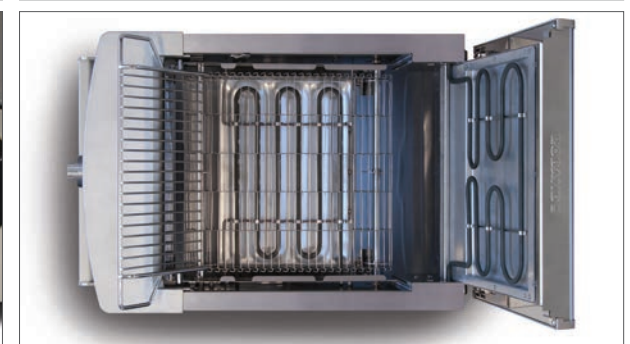

Features

<p>Toasting speed controller with electronic lock setting feature</p>	<p>Indicator light for auto-sensing feature</p>	<p>Bun toasting mode (up to 30 mm thickness)</p>	<p>Removable crumb tray for ease of cleaning</p>
			
<p>Lid-lock release lever to lift lid</p>	<p>LED lights illuminate the toast holding bay</p>	<p>Hinged top cover for easy access to clean inside</p>	
			

Model Details

MODEL	COLOUR	SLICES / HR (min)	CURRENT Amps	POWER Watts	DIMENSIONS W x D x H (mm)	WEIGHT Kg
ST350A	Natural	350	10.0	2300	412 x 596 x 421	25
ST350AR	Red	350	10.0	2300	412 x 596 x 421	25
ST350AB	Black	350	10.0	2300	412 x 596 x 421	25
ST500A	Natural	500	13.0	2990	412 x 596 x 421	25
ST500AR	Red	500	13.0	2990	412 x 596 x 421	25
ST500AB	Black	500	13.0	2990	412 x 596 x 421	25

Dimensions

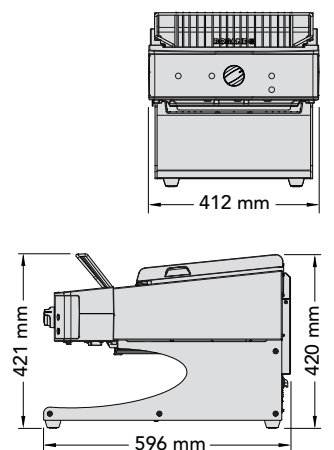

Distributed by: **ROBAND®** 

Roband Australia Pty Ltd

1 Inman Road
Cromer, NSW 2099
Australia
Tel: +61 2 9971 1788
Fax: +61 2 9971 1336
Email: roband@roband.com.au
www.roband.com.au

Roband New Zealand Ltd

Greenmount Drive
East Tamaki
New Zealand
Tel: +64 9 274 1355
Fax: +64 9 274 1356
Email: roband@roband.co.nz

Roband Europe Ltd

Haygarth Park, Blaenau Ffestiniog
Gwynedd, North Wales
LL41 3PF, United Kingdom
Tel: +44 (0) 1766 830 456
Fax: +44 (0) 1766 831 170
Email: info@metcalfcatering.com
www.metcalfcatering.com

Distributor: